

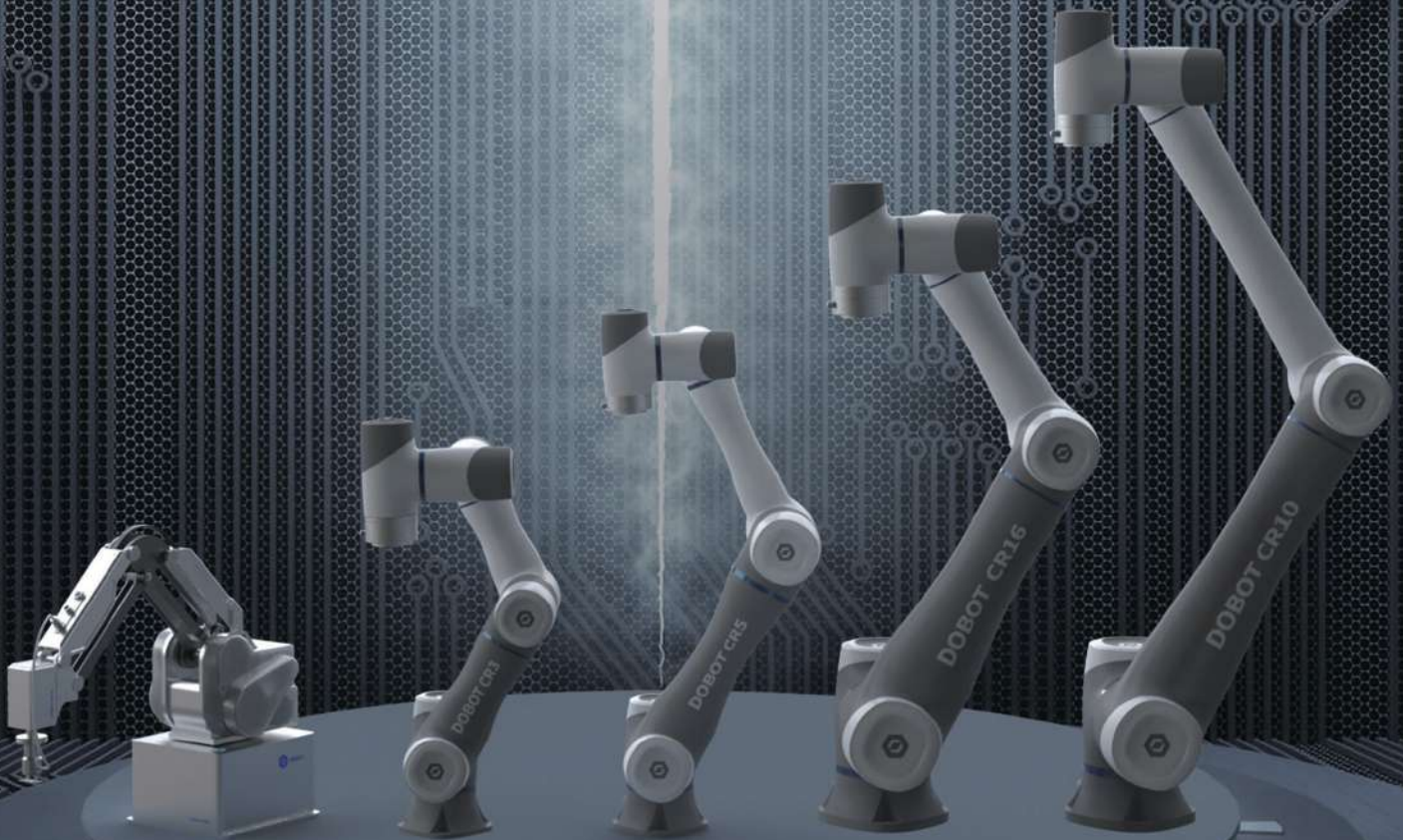

READYCOBOT



**All-perceptive Intelligent
Industrial Robot
Solution Expert**

ABOUT DOBOT

A B O U T D O B O T

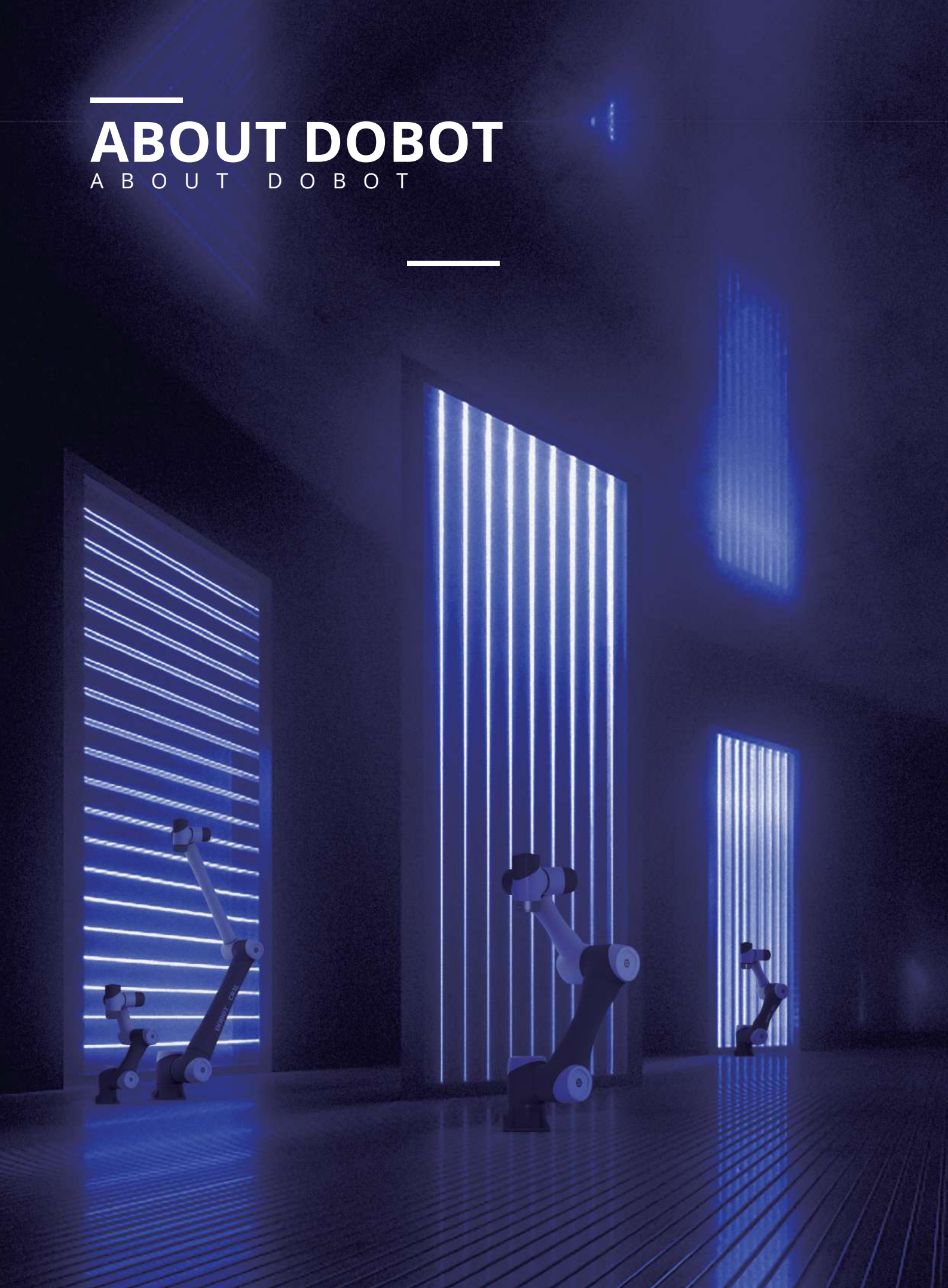

DOBOT is a world-leading provider of intelligent robotic arms. Our solutions seamlessly integrate AI-powered lightweight robotic arms and a proprietary software suite, effectively aiding industrial clients in navigating around rising wages, a lack of qualified laborers, and other bottlenecks, preventing companies from scaling. By replacing traditional manufacturing processes with advanced human-machine collaboration models, DOBOT meets the demands required for flexible production. It also plays a critical role in elevating China's manufacturing industry. In the future, DOBOT will become the future standard for the smart production process.

In addition, DOBOT is proud to increase spearheading robotic arm awareness in education and research.

We have partnered with a globally renowned K12 education company and other well-qualified academic institutions, offering DOBOT robotic arm solutions to over 1 million educators and researchers.

DOBOT prioritizes customers and values independent innovation. In the past six years, since

DOBOT's

one founding, we have been developing our own solution regarding key technologies. Our team is always step ahead, creating new product categories and setting new smart production standards to support the manufacturing industry.



DOBOT CR Collaborative Robot Series

Safe, Flexible, and Self-learning Collaborative Robot Series

SAFE, FLEXIBLE, AND SELF-LEARNING

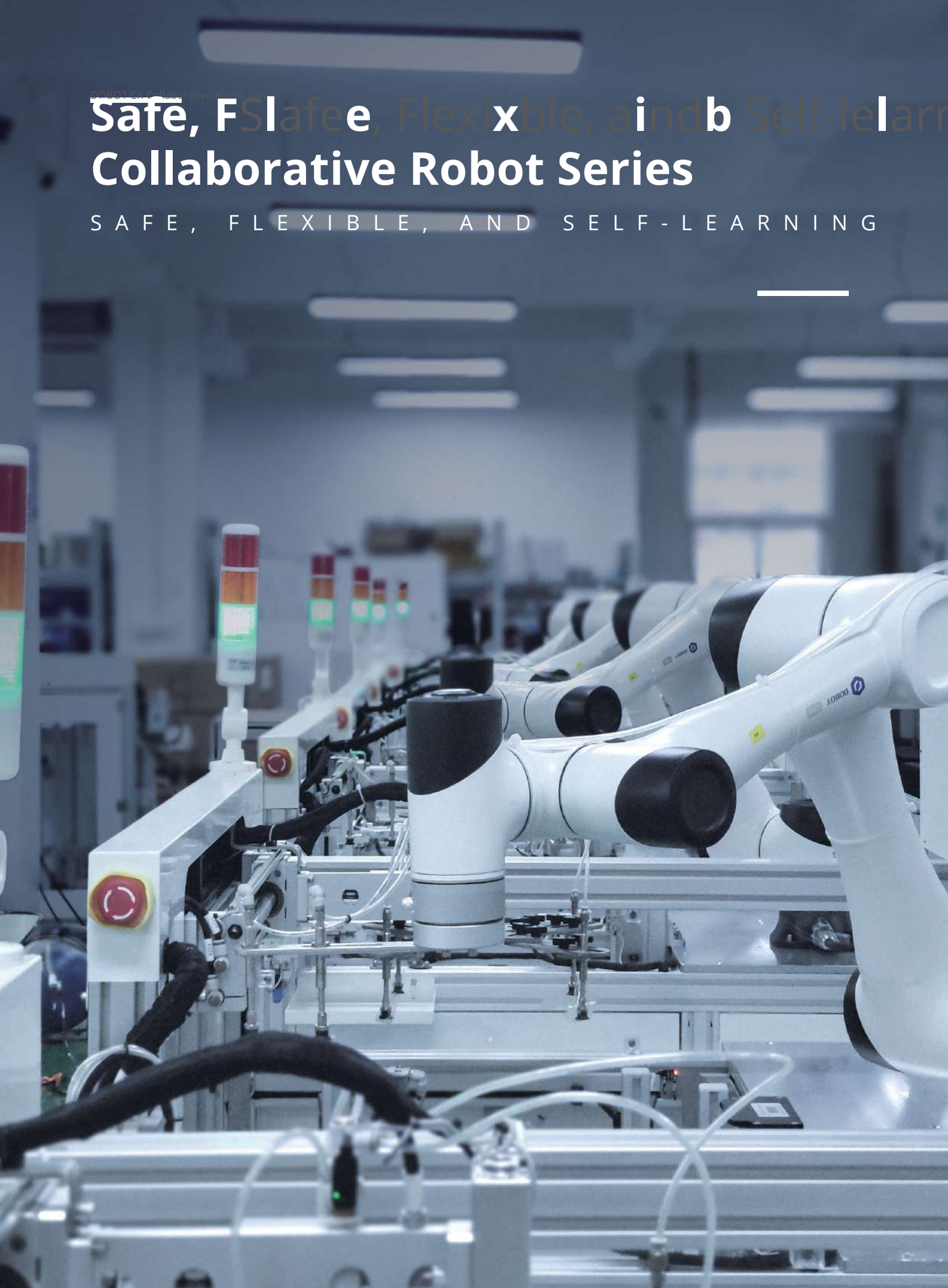



The CR series is a collaborative line of robots that DOBOT launched. CR series cobots have payloads of 3kg, 5kg, 7kg, 10kg, 12kg, and 16kg. These cobots are safe to work alongside, cost-effective, and adaptable in a variety of scenarios. CR Cobots offer flexible deployments, hand-guided learning, collision monitoring, trajectory reproduction, and other functions, increasing its suitability for human-robot collaboration scenarios.

Easy to Use | Easy to Learn and Master | Easy to Control

- Graphical programming, intuitive and easy to understand, easy to start and ready to use
- Intelligent interactive terminal panel, hand-guided learning, and system joint debugging are done in a single hand
- Real-time controls on your mobile phone, PAD smart terminal app, low delay and

Safe | Safe Production | Worry-free Collaboration

- 0.01 s real-time dynamic monitoring, 15cm space pre-touch perception, and advanced perception for preventive measures
- Based on force sense, electromagnetism, vision, multiple active security protection, layers collaborate to achieve the safest environment
- Spatial perception and online planning are perfectly combined to actively select the

Convenient | Flexible Deployment, One Step Ahead

- Fast setup requiring only 20 minutes to set up, 1 hour to initiate. It provides portable deployment in a time-saving and efficient manner
- Wide compatibility with mainstream end-effectors and accessories that meet the needs of flexible manufacturing multi-scenarios, and flexibly expand plug and play
- Intelligent adaptation to tailored needs, fast changeovers perfect for customized & flexible manufacturing

Economy | Smart Choice, Cooperation, and Mutual Benefit

- Smaller working space, less protection investment, safe and flexible in limited spaces
- 32,000 hours of service life, advanced energy-feeding technology, 100-watt energy consumption, durable and efficient long-term benefits

Product Features

DOBOT CR Series
DSaO(Bc,D FTle CoRib CleJ atambdo Sraetilly-lee
Baronbinorg SCEonlleaborative Robot Series Safe,
Flexible, and Self-learning Collaborative Robot Series

Flexible Deployment, One Step Ahead

DOBOT CR Collaborative Robot Series, simple design and wiring;

Fast setup requiring only 20 minutes, 1 hour to initiate

Flexible deployment, time-saving and efficient.



Wirelessly Interconnected Completely in Control

The CR series can be controlled through your mobile phone, PAD smart terminal app, low delay and strict disturbance immunity. Supports Android, iOS, Windows, and other platforms and with a high-performance WLAN card, the transmission velocity can reach up to 433Mbps, far greater than ordinary 150Mbps wireless WLAN cards.





Easy to master & Easy to control

The top of the robot sixth axis is equipped with our unique intelligent interactive panel with a proprietary lighting system, which can easily display the robot's status and quickly switch between enabling and disabling states.

With the push of a button, you can obtain drag and move teaching, recording, and reproducing trajectories, while controlling jaws, suction cups, or other custom fixtures and equipment. Users can easily control the system and make joint debugging using only one hand.



Product Features

DOBOT CR Series
Safe, Flexible, and Self-learning Collaborative Robot Series

Flexible Ecology Expansion





























The main applications you can use here are loading and unloading, assembly, testing, handling, screwing, grinding, spraying, and others. To succeed in the aforementioned applications, it is often necessary to configure different ends to combine them together. The most common endpoints include fixtures, vision, force sensors, etc.

Featuring multiple I/O and communication interfaces allows the CR collaborative robot series to be expandable

and

compatible with many end-of-arm tools:

The plug-and-play approach for a plug-in is easy to match and quick to select, including application scenarios.

 Robotiq Gripper	 SCHUNK Gripper	 Onrobot Gripper	 DH-Robotics Gripper
 Rochu Gripper	 Robotiq Gripper	 Onrobot Gripper	 SRT Gripper
 Robotiq Sensor	 KUNWEITECH Sensor	 Link-touch Sensor	 ATI Sensor
 COGNEX Vision	 MICROSCAN Vision	 Hikvision Vision	 ALSONTECH Vision
 YOUIBOT AGV	 Standard Robots AGV	 SEER AGV	 AGILEX ROBOTICS AGV
 DynaBrade Orbita Sander	 Onrobot Screwdriver	 Robotiq Screwdriver	 Schmalz Vacuum Gripper
 STICKÔBOT INC ONESTICK	 3D Connexion SpaceMouse	 Zacobria Controller	 HUATU Teaching Pendant



Auto Manufacturing



3C



Chemical



Medical



Semiconductors



Retail

Loading and Unloading

Spraying
Assembly
Inspection
Screwdriving
Pick and Place

Loading and Unloading

Welding
Assembly
Gluing
Handling
Palletizing

Loading and Unloading

Handling
Labeling
Measuring
Testing
Tending

Extracting liquid

Mixing liquid
Moving liquid
Cutting bone
Biops
Puncturing

Loading and Unloading

Photoetching
Cleaning
Sculpting
Subside
Tending

Pick and Place

Sorting
Handling
Packaging
Making latte art
Baking

Further SDK Development

Provides a ton of application packages, including SDK development packages, helping you quickly implement industrial and commercial application scenarios.

Supplemented by the corresponding software API, DOBOT cobot constitutes an open platform where

most system accessories are supported.

Plug and play function meets the needs of flexible manufacturing across multiple scenarios.



Collision-Free Collaboration

Dobot SafeSkin is a wearable silicone collision detection product specifically tailored for collaborative robots. With electromagnetic induction, a large coverage area, long perception distance, and fast response velocity, DOBOT SafeSkin can react quickly to avoid contact or injuries with electromagnetic objects. Unlike traditional collision detection solutions for collaborative robots, Dobot SafeSkin uses pre-collision and pre-perception technology to provide non-contact proximity perception and collision prevention for collaborative robots, ensuring high productivity and safety solutions for human-robot collaboration.

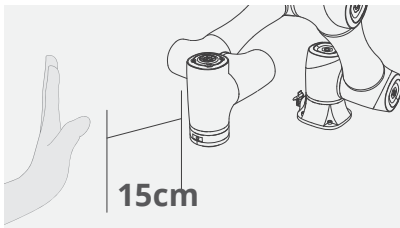

Long-distance spatial perception

15cm perception distance, effectively protects the operator from the robot arm impacts and injuries

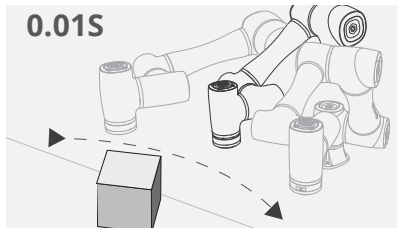

High sensitivity and rapid response

0.01ms response sensitivity, achieves higher sensitivity and responsiveness for collaborative human-machine security interactions

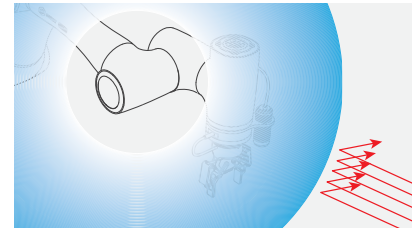

Stable anti-interference operations

Shielding technology allows you to resist interference from source signals at worksites and support a good environment for stable robot operations

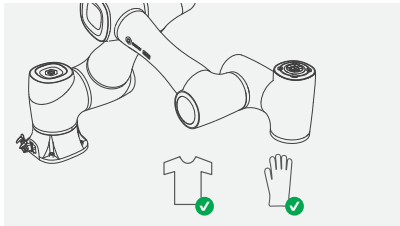

Comprehensive safety guaranteed

The sensing ability is unaffected by fabric, plastic gloves, and other shelters and light conditions, creating comprehensive security

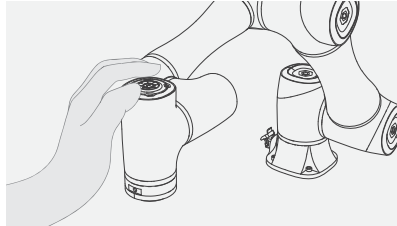

Quick installation

Dobot SafeSkin adopts a humanized design, making it easy to operate and be installed in the fastest way

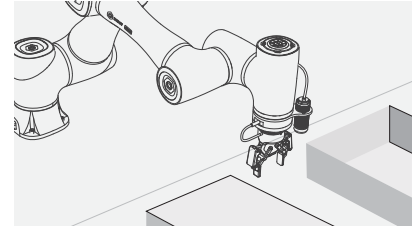

Guaranteed robot performance

While in use, the SafeSkin will rarely cause performance losses for the robot, ensuring efficient production

Wearable silicone collision design

In the non-contact safety program, the industry's first silicone SafeSkin, compared to metal, plastic, and other materials, has higher collision cushioning, feels soft, and is maintainable and self-recoverable; it has a wearable integrated design, is quick to install and easy to start, simple to operate, and ready to use.

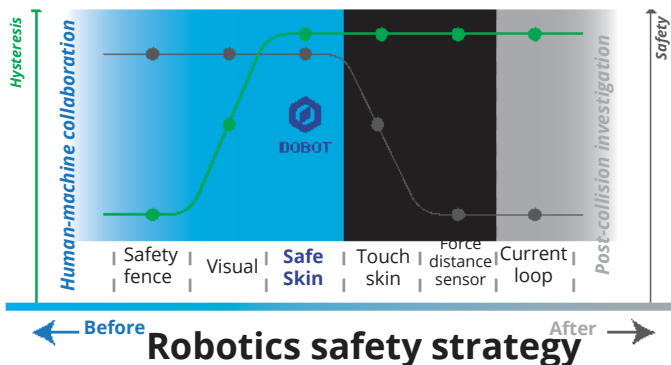

Non-contact and Safe Feature



Control Software for CR Cobot Series

DOBOT SCStudio

SCStudio, the Windows control software for CR cobots, supports user-friendly interface programming. It provides users with secondary utilization and a multi-tude of kinematic algorithms for mechanical structures. SCStudio has a built-in virtual simulation environment for quicker development of various application scenarios.



CRStudio

CRStudio, the mobile control software for tablets, supports graphical programming. It is intuitive and easy to understand even for users with the insufficient programming experience.

For advanced users, the platform also provides script programming, which can

be quickly mastered and seamlessly switched. CRStudio provides multiple programming methods for you to choose from, up to your needs.





Auto Manufacturing

Automobile manufacturing is one of the most automated industries. Among its four major processes, stamping, welding, and painting have been mostly automated with industrial robots replacing workers and technical engineers who control the robots' performance. Due to the complexity and flexibility, the assembly process is not applicable for traditional robots. Collaborative robots work alongside operators, improving the entire factory's efficiency.

Pain Point Solutions

- 1. More Flexibility:**
Unlike traditional industrial robots, cobots can be deployed more flexibly.
- 2. Reliability:**
Repeatability is up to 0.02mm, satisfying the installment of high-quality motors.
- 3. Fewer Requirements for Working Environments:**
Immune to the noise and brightness as a result of welding operations at the workplace.
- 4. Lower Labor Costs:**
Amid rising labor costs, cobots effectively minimize factory costs.

Applications

Loading
and
Unloading

Spraying

Assembly

Inspection

Screw-
driving

Pick and
Place



DOBOT CR Collaborative Robot Series

can be useful in automation scenarios of automobiles and relevant components, including dip-coating, spraying, loading and unloading, screwdriving, pick and place, and machine tending.



3C

Computers, Communications, and Consumer Electronics make up what's commonly referred to as the 3C industry in China. Manufacturing in the 3C industry features large quantities, frequent updates, significant labor, and highly repetitive tasks.

Pain Point Solutions

- 1. Flexibility:**
Adaptable to a variety of small fractions of production lines.
- 2. Consistency:**
Delivers consistent assembled products, allowing to have a better quality control system.
- 3. Efficiency:**
Compared to human counterparts, robots can work more quickly and efficiently, creating more value.
- 4. Reliable:**
Robots offer greater reliability and performance than humans and thus better quality products.

Applications

Loading
and
Unloading

Welding

Assembly

Gluing

Handling

Palletizing

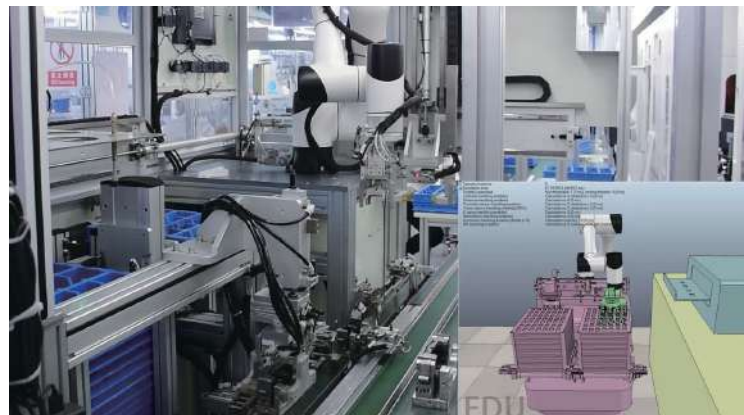

DOBOT CR Collaborative Robot Series

are equipped with force sensing and electronic skin devices, which can easily perform 3C assembly tasks (power supply assembly and locking) and 3C loading and unloading (plasma cleaning machine loading and unloading).



Chemical Industry

In an era when manufacturing is becoming more flexible and intelligent, IoT technologies are penetrating our lives. Bar codes as a carrier for recognizing items have been widely applied in logistics management systems in the chemical industry. Over the years, more and more businesses turn to robots replacing employees to do labelling because of cobots' higher efficiency.

Pain Point Solutions

1. Less Requirements for Working Environments:

Adaptable to a variety of work conditions, including those with high heat, toxic gases, and radiation.

2. Wider Applications:

Applicable to all kinds of labeling of plastics products, such as box bodies, rod bodies, pipe bodies, and shells.

3. Accurate and Reliable with Low Error Rates:

It can accurately and efficiently attach labels to the designated position and avoid labeling errors, eliminating material mixing.

4. Convenient & Easy to Use:

Simple single-hand guidance and interactive programming can become useful guides for robots.

Applications

Loading
and
Unloading

Handling

Labeling

Measuring

Testing

Machine
Tending



DOBOT CR Collaborative Robot Series

are used in the production line of a Malaysian chemical company for labeling operations, helping it grow.

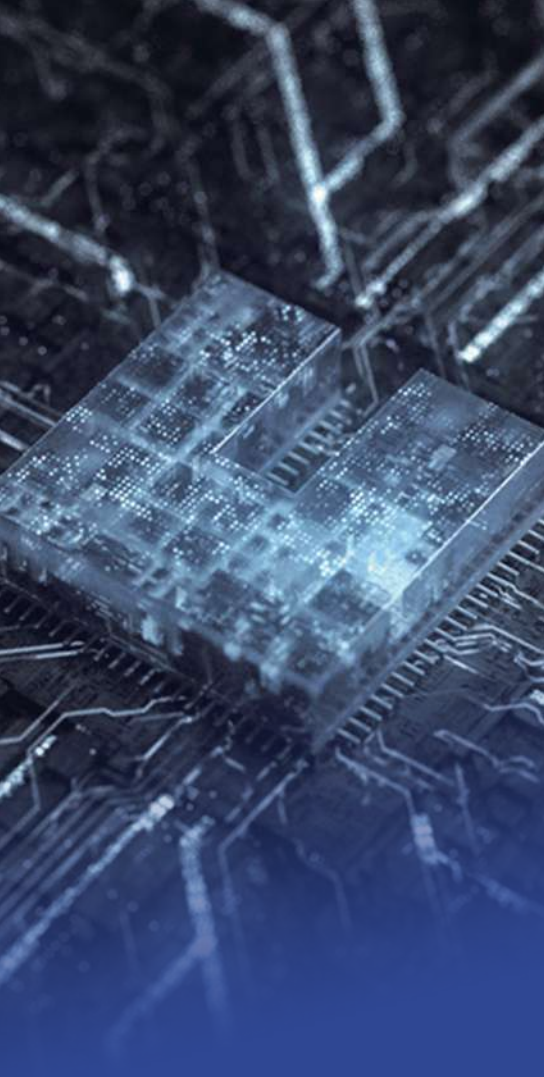

Semiconductors

Manufacturing states for 46% among the global semiconductor industrial value chain lines. Therefore, it is the most valuable share in the semiconductor industry and can also drive development throughout the entire industry. Among the three major segments of China's mainland semiconductor industry, the manufacturing segment is relatively weak, with a value share of only 26%.

Pain Point Solutions

1. Flexibility:

Adaptable to a variety of small fraction semiconductor production patterns, preventing frequent changeovers and saving time.

2. Efficiency & Reliability:

High velocity and efficient products are a perfect fit for short-run, high efficiency, and fast-paced semiconductor manufacturing, greatly improving the quality of products.

3. Convenient & Easy to Use:

Simple single-hand guidance and interactive programming can become useful guides for robots. They can learn to work quickly, easily meeting all the production requirements for various types of manufacturing, including small batches.

Applications

Loading
and
Unloading

Photoetch-
ing

Cleaning

Sculpting

Precipita-
tion

Machine
Tending



With the above features, DOBOT CR Collaborative Robot Series

have been successfully applied in the semiconductor industry to increase efficiency and reduce costs for enterprises.



Medical

As one of the most notable areas, medical professionals are often prone to long working hours, high-intensity work tendencies, and a special environment. Turning to robots can solve these problems. Medical robots are easy to use and highly adaptable, which can help expand the scope of surgeons' professional skills.

Pain Point Solutions

1. Safe:

Combined with force torques, DOBOT cobots are very safe to work alongside, helping you complete different procedures across various environments.

2. Versatile:

DOBOT cobots can be combined with different types of flexible grippers, greatly enhancing the scope of robotic work.

3. Simple:

The operator can teach the robot's motion paths and fixtures by dragging and dropping, eliminating the need for a handheld demonstrators and allowing high-class hands-on teaching.

Applications

Extracting
liquid

Mixing
liquid

Moving
liquid

Bone
cutting

Biops

Puncturing



DOBOT CR Collaborative Robot Series have been widely



Retail

The emergence of unmanned retail stores and smart vending machines has allowed robots to slowly become a mainstay in people's lives. Innovative consumer formats, such as unmanned retail stores and smart vending cabinets, are improving the way of brick-and-mortar stores operate. Novel smart production also reduces costs for the stores' maintenance.

Pain Point Solutions

1. Convenient & Fast:

Customers only need to place an order online, and the robot can immediately process the order.

2. Cost Saving:

Using robots can reduce many labor costs and extend operating hours to 24/7, improving utilization time and reducing rent per unit.

3. Powerful Customer Magnet:

With an intelligent robot system in place, a restaurant or shop will attract more customers.

This content will be posted on social media becoming more open to publicity. Eventually, it can lead to improving the store's operating income.

Applications

Pick and Place

Sorting

Handling

Packaging

Art of making latte

Baking



DOBOT CR Collaborative Robot Series have been successful

CR3

Industries

Food & Chemical
Furniture &
Appliances Metal
Processing
Auto Components
3C Automation

Applications

Product Line Tracking in 3C Industry
Dynamic Screwdriving
Production Line Assembly
Small Loading and Unloading

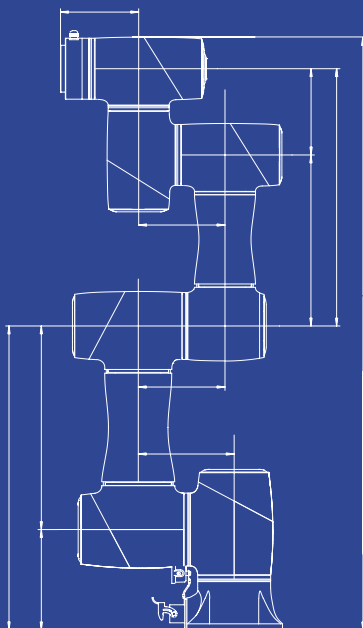

Scope of Work

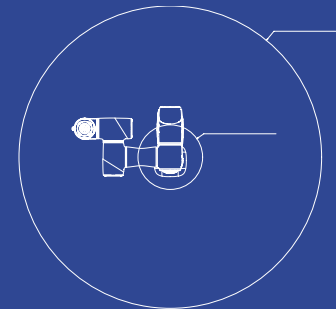
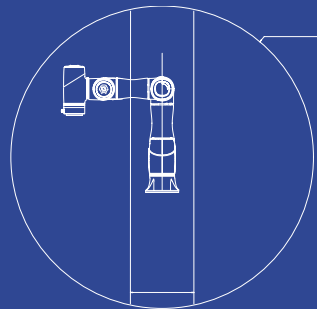

CR3L

Industries

Food & Chemical
Furniture &
Appliances Metal
Processing
Auto Components
3C Automation

Applications

Product Line Tracking in 3C Industry
Dynamic Screwdriving
Production Line Assembly
Small Loading and Unloading

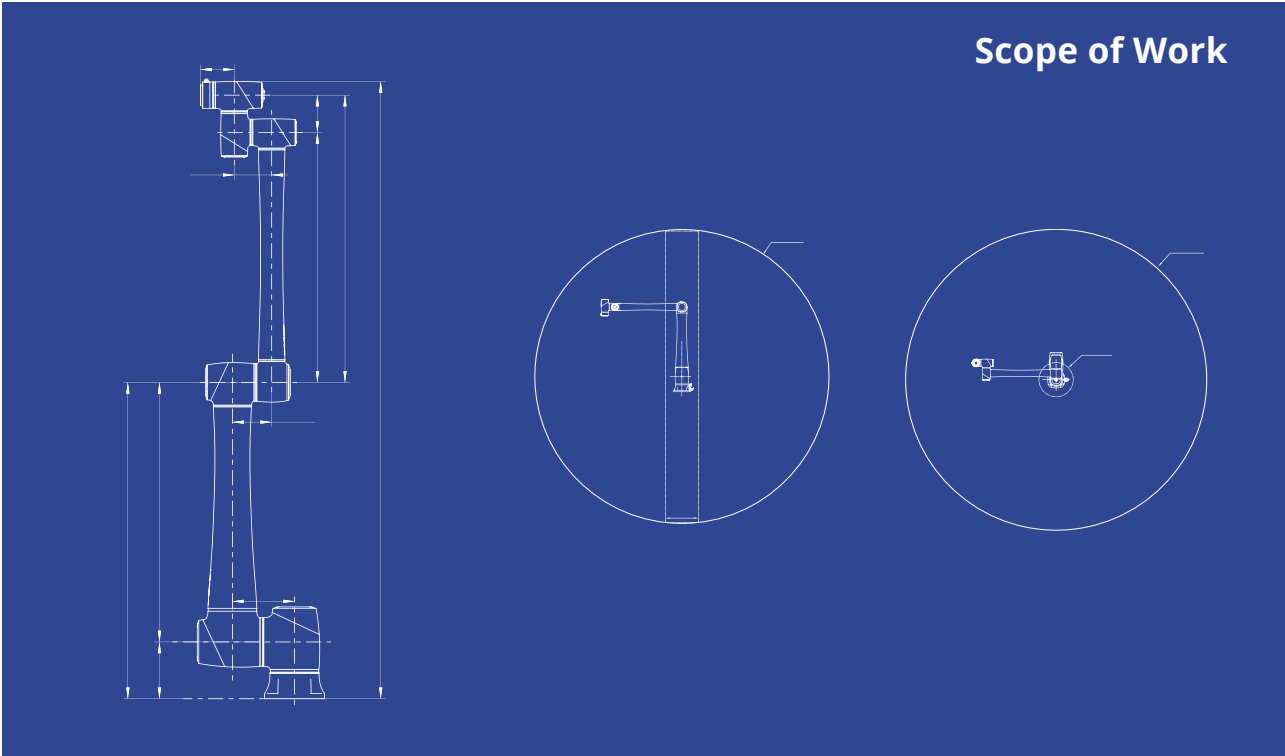

CR5

Industries

- 3C Automation
- Food Packaging
- Furniture & Appliances
- Metal Processing
- Auto Spare Parts

Applications

- Assembly Line Loading and Unloading
- Dynamic Screwdriving
- Production Line Assembly
- Material Processing (Polishing & Sanding)



Scope of Work

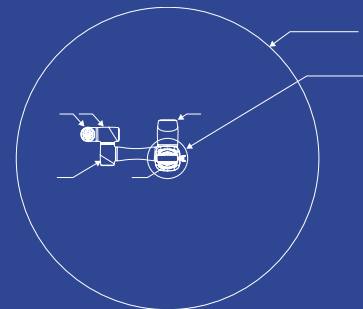
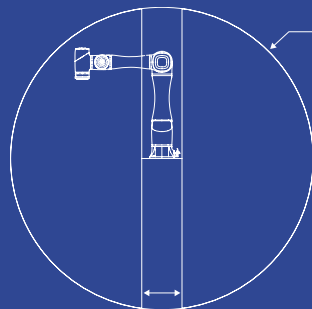
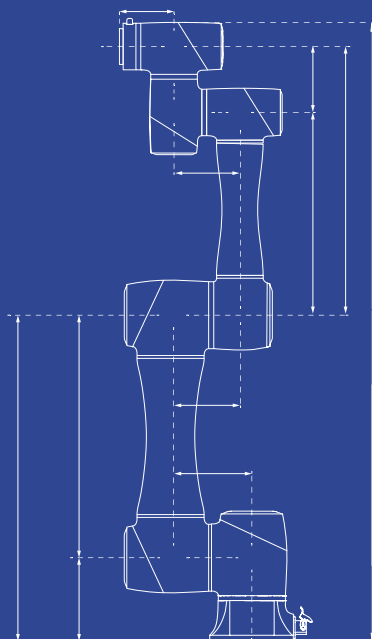

CR7

Industries

- 3C Automation
- Food Packaging
- Furniture & Appliances
- Metal Processing
- Auto Spare Parts

Applications

- Assembly Line Loading and Unloading
- Dynamic Screwdriving
- Production Line Assembly
- Material Processing (Polishing & Sanding)



Scope of Work

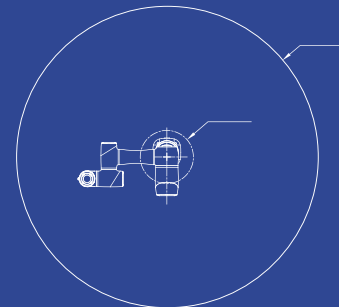
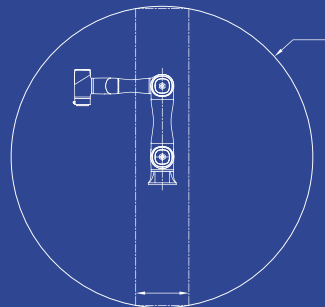
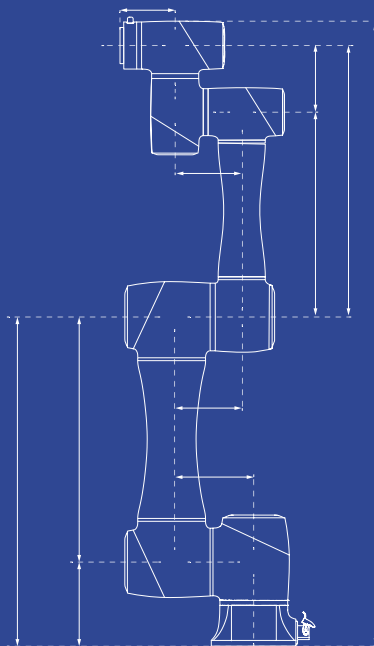

CR10

Industries

Food & Chemical

Furniture &

Appliances Metal

Processing

Auto Components

Applications

Machine Tool Loading/ Unloading

Heavy Duty Pick and Place

Depalletizing & Palletizing

Material Processing (Polishing & Sanding)



Scope of Work

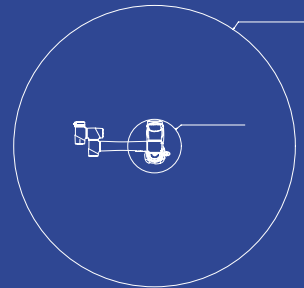
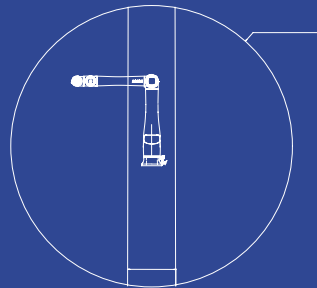
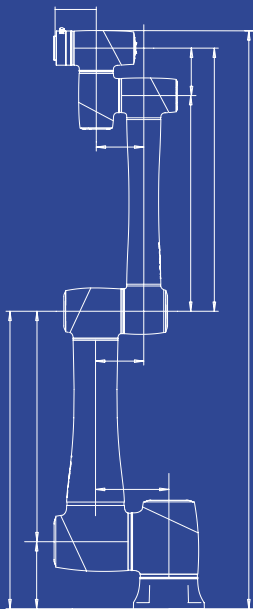

CR12

Industries

Food & Chemical
Furniture &
Appliances Metal
Processing
Auto Components

Applications

Machine Tool Loading/ Unloading
Heavy Duty Pick and Place
Depalletizing & Palletizing
Material Processing (Polishing & Sanding)

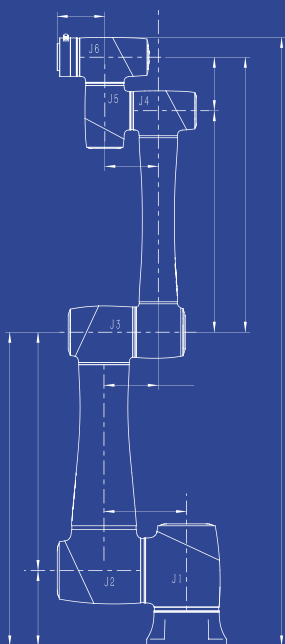

Scope of Work

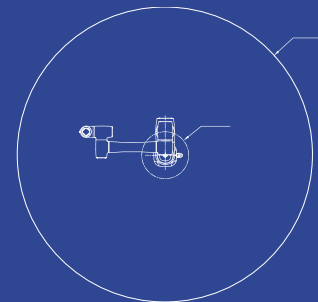
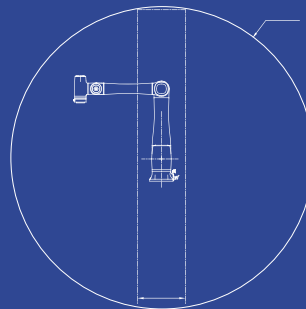

CR16

Industries

Medical & Chemical
Furniture &
Appliances Metal
Processing
Auto Manufacturing

Applications

Machine Tool Loading/ Unloading
Heavy Duty Pick and Place
Depalletizing & Palletizing
Material Processing (Polishing & Sanding)



Scope of Work

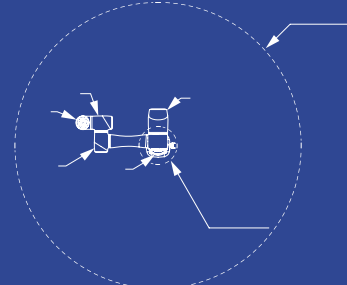
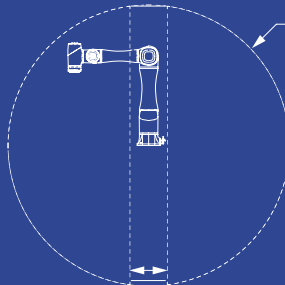
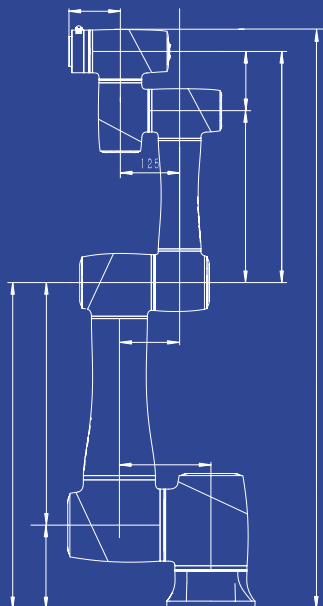

CR Collaborative Robot Series

Specifications



Product Name	CR3	CR3L	CR5	CR7
Weight	16.5kg	39.5kg	25kg	24.5kg
Rated Payload	3kg	3kg	5kg	7kg
Reach	620mm	1700mm	900mm	800mm
Max. Reach	795mm	1919mm	1096mm	990mm
Rated Voltage	DC48V	DC48V	DC48V	DC48V
Max. Speed of TCP	2m/s	4m/s	3m/s	3m/s
J1	±360°	±360°	±360°	±360°
J2	±360°	±360°	±360°	±360°
Joint J3	±155°	±170°	±160°	±160°
Ranges J4	±360°	±360°	±360°	±360°
J5	±360°	±360°	±360°	±360°
J6	±360°	±360°	±360°	±360°
Max. Speed of Joints	180° /s	120° /s	180° /s	180° /s
J1/J2	180° /s	180° /s	180° /s	180° /s
J3/J4/J5/J6	180° /s	180° /s	180° /s	180° /s
End-Effector DI/DO/AI			2	
I/O Interface			0	
Communication			RS485	
Inter-Communication				
face				
DI			16	
DO/DI			16	
Controller AI/AO			2	
I/OABZ Incremental				
Encoder			1	
Cable length from body to cabinet			5M	
Repeatability			±0.05mm	±0.02mm
Communication	±0.02mm		TCP/IP, Modbus TCP, EtherCAT, WIFI	±0.02mm
IP Rating			IP54	
Temperature			0°C -45°C	
Power Consumption			300W	150W
Materials	120W		Aluminum alloy, ABS plastic	150W

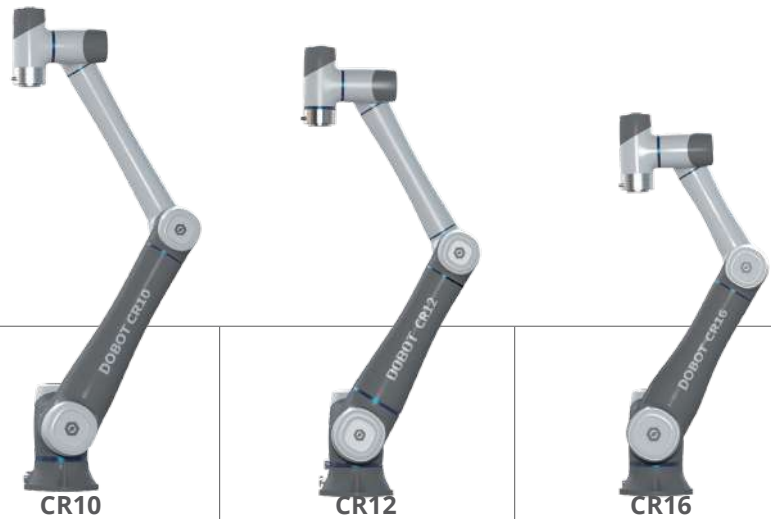

Product Name		CR10	CR12	CR16
Weight		40kg	39.5kg	40kg
Rated Payload		10kg	12kg	16kg
Reach		1300mm	1200mm	1000mm
Max. Reach		1525mm	1425mm	1223mm
Rated Voltage		DC48V	DC48V	DC48V
Max. Speed of TCP		4m/s	4m/s	3m/s
Joint Range s	J1	±360°	±360°	±360°
	J2	±360°	±360°	±360°
	J3	±160°	±160°	±160°
	J4	±360°	±360°	±360°
	J5	±360°	±360°	±360°
	J6	±360°	±360°	±360°
	J1/J2	120° /s	120° /s	120° /s
Max. Speed of Joints 3/4/5/6	180° /s	180° /s	180° /s	
DI/DO/AI		2		
End-Effector I/O Interface	AO	0		
	Communication	RS485		
Communication Interface	DI	16		
	DO/DI	16		
Controller I/O	AI/AO	2		
		1		
	ABZ Incremental Encoder	5M		
	Cable length from body to cabinet	±0.03mm		
Repeatability		±0.03mm	TCP/IP, Modbus TCP, EtherCAT, WIFI	±0.03mm
Communication		IP54		
IP Rating		0°C -45°C		
Temperature		350W		
Power Consumption		350W	Aluminum alloy, ABS plastic	350W
Materials				

Controller Specifications



CC16X

Model	
Size	360mm (Length)*160mm (Width)* 402.4mm (Height)
Control Cabinet Weight	12kg
Controlled Axes	6 Axes + External Expansion Axes
Power Input	Single Phase 110V/220V AC, 7.5A, 50/60HZ
Power Output	48V, 20A
Supported Motor Power (Max)	-
Braking Resistors	Four, 17W, 10Ω
Supported Encoder Types	-
Communication Interface	EtherCAT (for External Axes), Ethernet
I/O Interface	16 Digital Outputs
	16 Digital Inputs/Outputs (Multiplexing)
	2 Analog Outputs (Voltage: 0V-10V, Current: 4mA-20mA)
	2 Analog Inputs (Voltage: 0V-10V, Current: 4mA-20mA)
	1 Incremental Encoder ABZ Input
Teaching & Playback Method	Hand-Held Teaching Pendant/APP
Programming Language	Script
	Graphical Programming (Blockly)
Installment	Floor
Environment	Temperatures: 0°C ~45°C, Humidity:≤95%, No Condensation
Protection Rating	IP20
Cooling Method	Forced-Air Cooling
Safety Features	Emergency stop function, reserved external security interface that can be controlled by I/O interface
Indicator	The indicator light remain red when the power is on and be off when the power is off.
Maintenance	Diagnostic Software Tool
	Power-off Zero Save
	Reserve Remote Service

MG400

Ultra-small desktop robot arm

SAFE, FLEXIBLE, AND SELF-LEARNING





DOBOT MG400 is an ultra-small desktop robot arm that occupies space smaller than A4 paper. The MG400 is designed for diverse mini-batches of automation with a maximum load of 750 grams and a 440 mm arm that meets the needs for lightweight desktop applications, conversion teaching, collision detection, and other human-machine collaboration features. They allow the MG400 to apply rapid deployment of production line applications, providing a highly competitive choice for automated intelligent production.

Small Space Occupation

To fully utilize production space and easily integrate existing production environments, the MG400 has adopted a controller, the body integrated structure design, and the base frame area of only 190mm X 190mm that can fit A4 paper space.

Professional Performance

The M400 is equipped with a high-precision absolute encoder integrated into servo motors. Coupled with a self-developed servo drive and controller, the robot's repeatability can be measured up to $\pm 0.05\text{mm}$.

With the vibration suppression algorithm in the controller and ensured

trajectory

accuracy of multi-axis motion, the repeatability bandwidth stabilization time is accelerated by 60% and residual vibration by 70%.

Simplicity Means Productivity

Simplicity is integrated into every dimension of the robot, fully reducing the difficulty of deploying automation in small and medium-sized enterprises.

Shorter deployment time: integrated & compact design, flexible & easy to deploy,

plug
and play;

More programming options: trajectory reproduction, graphical programming,

and

Lua script programming, which are ideal for applications of different complexities
developers with different programming skills;

Higher programming efficiency: an intuitive programming interface and

guided-

interactive design can greatly improve efficiency and lower the barriers for
applications;

Higher debugging efficiency: when resetting the robot for debugging, lighter

and

integrated collaboration
Helps Automation
reduces programming difficulty with robot power compensation algorithms
point teaching time by more than 80%.

The collision detection function ensures safety. MG400's replacement of highly repetitive, standard procedures enables high-efficiency configurations of human-machine collaboration. MG400 can make desktop collaboration possible that will reduce costs and improve the quality of manufacturing for enterprises.

MG400



Scope of Work

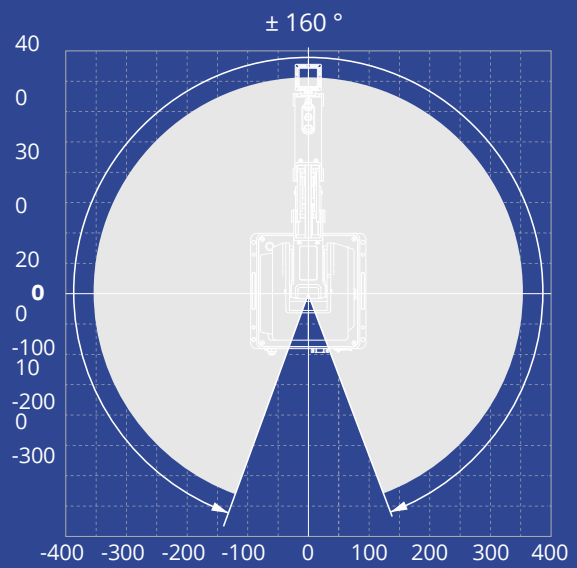
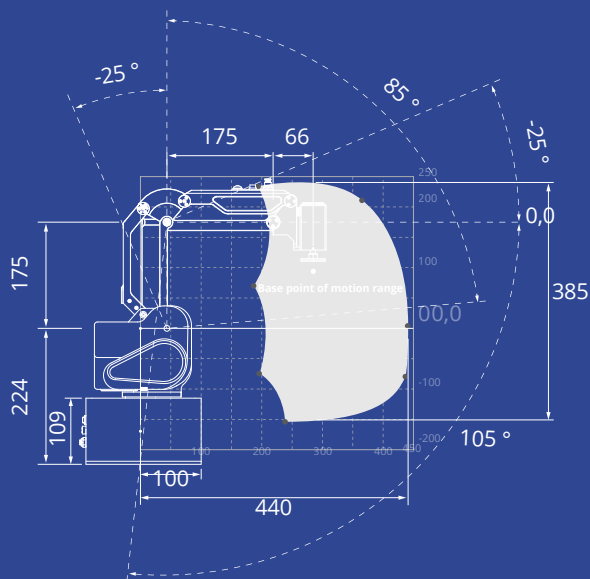

Specifications

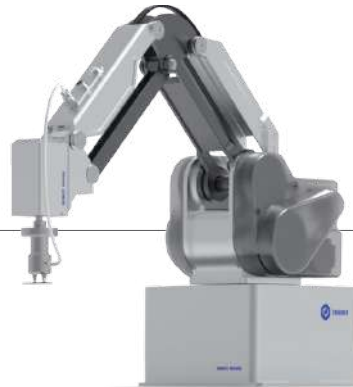



MG400

Product Name	MG400	
Product Model	DT-MG400-4R075-01	
Number of robot axes	4	
Payload	500g (Max 750g)	
Reach	440mm	
Repeatability	±0.05mm	
Range of joint motion	J1	±160°
	J2	-25° - 85°
	J3	-25° - 105°
	J4	-360° - 360°
Max. Speed of Joints	J1	300°/s
	J2	300°/s
	J3	300°/s
	J4	300°/s
Power Supply	100-240 V AC, 50/60 Hz	
Rated Voltage	48V	
Rated Power	150W	
Communication	TCP/IP, Modbus TCP	
Installment	Table Installation	
Weight	8kg	
Base Size	190mm × 190mm	
Working Environment	0 °C - 40 °C	
Application Software	DobotStudio 2020, SCStudio	

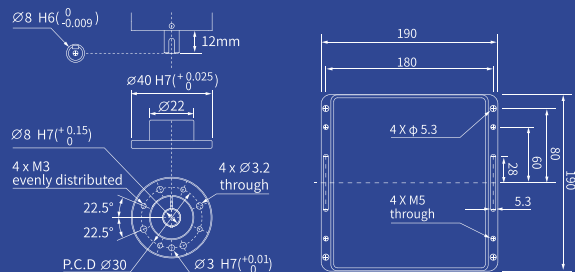
Base Mounting Holes

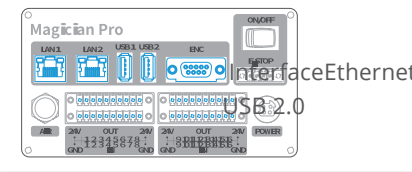

	Digital Input	1
	Digital Output	6
	Encoder Input	2
	Digital Input	1
	Digital Output	2
	Air way	2



DOBOT M1 PRO
Collaborative
SCARA Robotic Arm

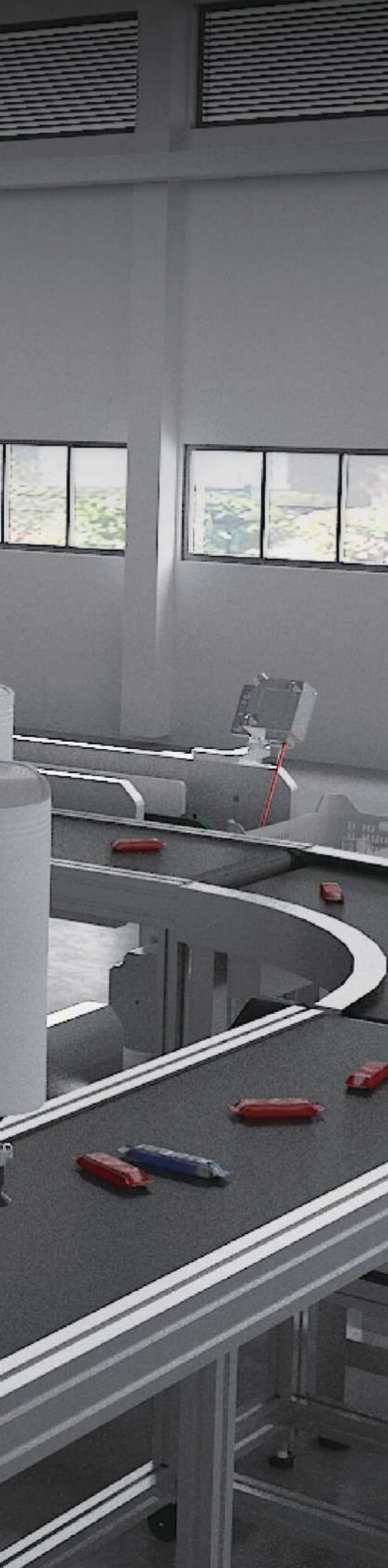

DOBOT M1 Pro is a lightweight, cost-effective, and fully-aware human-machine collaborative robotic arm for light industries. With high precision, vast working range, and complete functions, the M1 Pro has a repeatable end positioning accuracy of 0.02mm and a maximum arm span of 400mm. M1 Pro is perfect for industrial welding, visual identification sorting, PCB plug-in, and other functions, suitable for all types of assembly line operations. The M1 Pro supports secondary development, providing users with a wide scope of use.

Innovative Structural Development

Being a cost-effective collaborative intelligent robotic arm for light industries, M1 Pro is an integral part of innovative structural development. The entire integrated machine design embedded in the electric control cabinet eliminates wiring and cabling issues, improving the efficiency between the servo drivers and control system greatly.

With lightweight structural designs of large and small arms, the robot works more stably, moves more flexibly and quickly, and is perfectly competent for various applications.

While adopting encoders with higher accuracy and stronger anti-interference capabilities, control accuracy is significantly improved, and jitter phenomena are effectively reduced.

Adopts the Mature Intelligent Industrial Controller Architecture of DOBOT

M1 Pro has more powerful functions, more stable performance, and more diverse applications. It also acquires more sensitive collision detection and dragging teaching functions, enabling the robots with more collaborative attributes.

New incremental differential encoder interface extends dynamic capture and tracking applications.

Supports continuous trajectory interpolation, more uniform motion, and smoother trajectory; the application of point gluing provides more conditions.

Supports parallel processing, such as multi-threading and IO controls in effectively shortening robot motion beats.

More Concise and Humanized Operation Mode

Supports app programming and debugging, and can be directly controlled by smart terminals, such as mobile phones and PAD.

Innovative programming and an interactive interface for more efficient monitoring and debugging.

Supports users in secondary development and remote control, extending the opportunities.

M1 PRO



Scope of Work

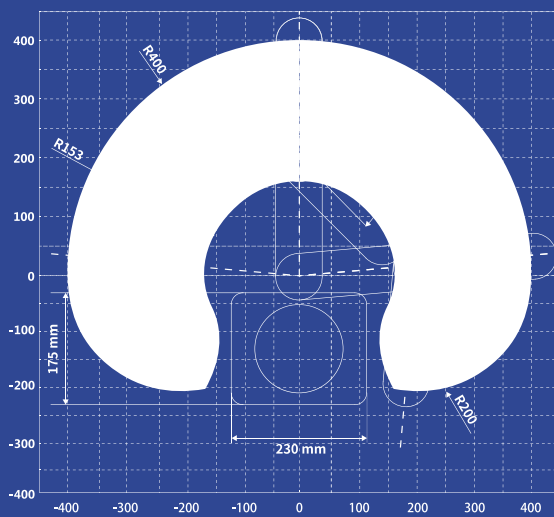
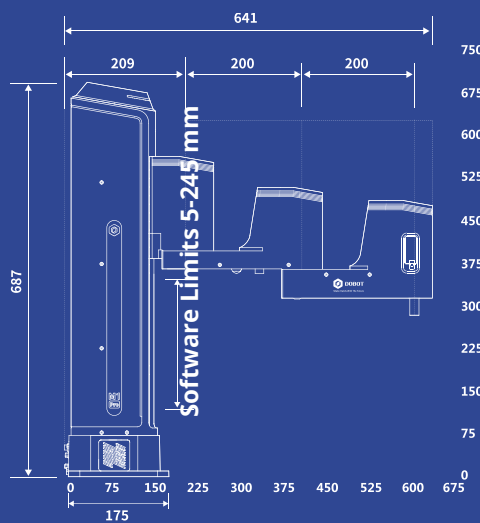

Specifications



Product Name	M1 Pro	
Arm Length	400mm	
Rated Payload	1.5kg	
Max. Range of motion	Classification	Software Limits
	Big arm	-85°-85°
	Small arm	-130° -130°
	Z-axis Greasing Screw Rod	5mm-245mm
Max. motion velocity	End rotation	-360° -360°
	Joint velocity of big and small arms	180° /s
	Resultant velocity of big and small arms	2000mm/s
Repeatability	Z-axis velocity	1000mm/s
	±0.02mm	
Power Supply	100V-240V AC, 50/60Hz	
Communication Interface	Ethernet、Modbus	
I/O	16 Digital Outputs 16-channel digital input	
Control Software	DobotStudio 2020、SCStudio	

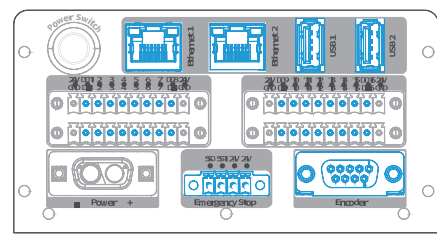
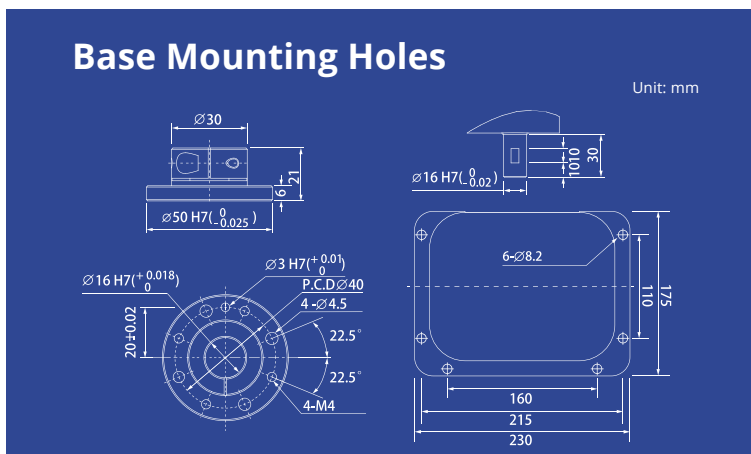

Base Interface		Terminal Interface	
Digital Input	1	Digital Input	4
Digital Output	6	Digital Output	4
Ethernet	1		
USB 2.0	6		
Encoder Input	2		
Emergency Stop Interface	2		
	1		



TECHNICAL SUPPORT

DOBOT offers multiple levels of training programs and resources for our partners to get started and nurture the engineers of tomorrow.



Quick Start



Core Functions



External Device Connections



Training & Development



Repair & Maintenance



FAQs



AFTER-SALES SERVICE

DOBOT always offers the professional after-sales service on time. If you have any questions about us, our technician will be happy to deal with any issues via:

support.enterprise@dobot.cc

READYCOBOT



contact:

Phone 574-266-5276

www.readycobot.com